

23184EA.M

Spherical Roller Bearings (metric)



Details:

Main dimensions			
d [mm]	420	D ₁ [mm]	≈ 605.9
D [mm]	700	d _s [mm]	12.5
B [mm]	224	n _s [mm]	23.5
Weight [kg]	≈ 357	r _{1,2} [mm]	6
d ₂ [mm]	≈ 505.3		

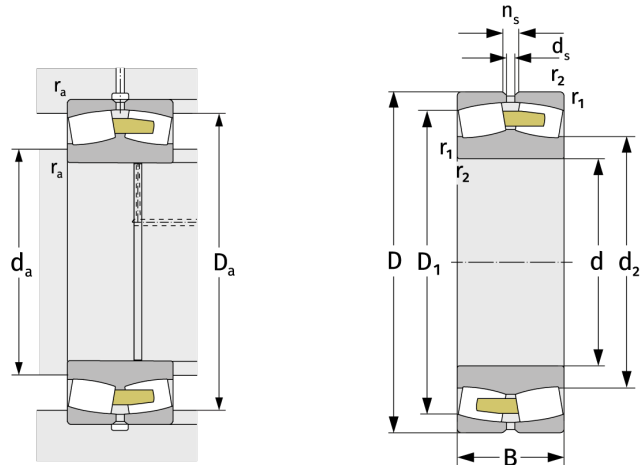

Mating dimensions		Calculation data	
d _{a,min} [mm]	446	C [kN]	5150
D _{a,max} [mm]	674	C ₀ [kN]	9850
r _{a,max} [mm]	5	C _u [kN]	656
		n _{th} [min ⁻¹]	453
		n _g [min ⁻¹]	830
		e	0,3
		Y ₁	2,25
		Y ₂	3,34
		Y ₀	2,2