

# 30264

Tapered Roller Bearings (single row, metric)



## Details:

Main dimensions			
d [mm]	320	B [mm]	92
D [mm]	580	d <sub>1</sub> [mm]	≈ 433.4
T [mm]	104	r <sub>1,2</sub> [mm]	6
Weight [kg]	≈ 103	r <sub>3,4</sub> [mm]	5
C [mm]	75	a [mm]	≈ 112.3

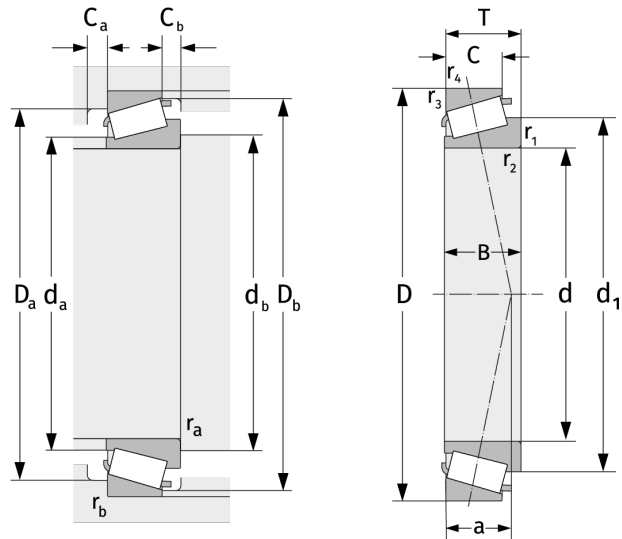

Mating dimensions		Calculation data	
d <sub>a,max</sub> [mm]	380	C [kN]	1870
d <sub>b,min</sub> [mm]	340	C <sub>0</sub> [kN]	2810
D <sub>a,min</sub> [mm]	501	C <sub>u</sub> [kN]	228
D <sub>a,max</sub> [mm]	556	n <sub>th</sub> [min <sup>-1</sup> ]	677
D <sub>b,min</sub> [mm]	536	n <sub>g</sub> [min <sup>-1</sup> ]	1100
C <sub>a,min</sub> [mm]	12	e	0,44
C <sub>b,min</sub> [mm]	29	Y	1,38
r <sub>a,max</sub> [mm]	6	Y <sub>0</sub>	0,76
r <sub>b,max</sub> [mm]	5		