

# 32244

Tapered Roller Bearings (single row, metric)



## Details:

Main dimensions			
d [mm]	220	B [mm]	108
D [mm]	400	d <sub>1</sub> [mm]	≈ 307.3
T [mm]	114	r <sub>1,2</sub> [mm]	5
Weight [kg]	≈ 59.9	r <sub>3,4</sub> [mm]	4
C [mm]	90	a [mm]	≈ 95.3

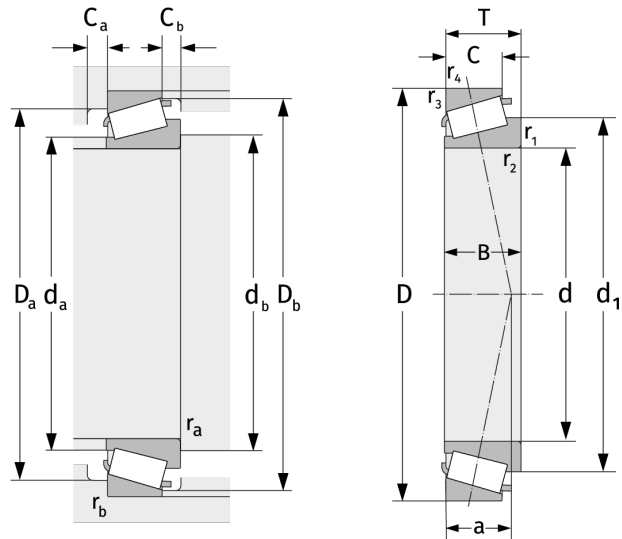

Mating dimensions		Calculation data	
d <sub>a,max</sub> [mm]	258	C [kN]	1610
d <sub>b,min</sub> [mm]	237	C <sub>0</sub> [kN]	2650
D <sub>a,min</sub> [mm]	336	C <sub>u</sub> [kN]	235
D <sub>a,max</sub> [mm]	382	n <sub>th</sub> [min <sup>-1</sup> ]	893
D <sub>b,min</sub> [mm]	380	n <sub>g</sub> [min <sup>-1</sup> ]	1700
C <sub>a,min</sub> [mm]	12	e	0,43
C <sub>b,min</sub> [mm]	24	Y	1,39
r <sub>a,max</sub> [mm]	5	Y <sub>0</sub>	0,77
r <sub>b,max</sub> [mm]	4		