

HM30/710

Grooved Nuts



Details:

Main dimensions

Weight [kg]	≈ 90.7	B [mm]	90
G [mm]	Tr710x7	b [mm]	50
		h [mm]	25
d ₁ [mm]	780		
d ₂ [mm]	830		

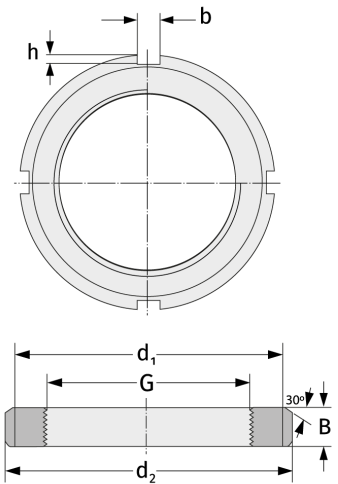

Mating dimensions

Containing components

Securing

MS30/710