

HM30/750

Grooved Nuts



Details:

Main dimensions

Weight [kg]	≈ 95.1	B [mm]	90
G [mm]	Tr750x 7	b [mm]	55
		h [mm]	25
d ₁ [mm]	820		
d ₂ [mm]	870		

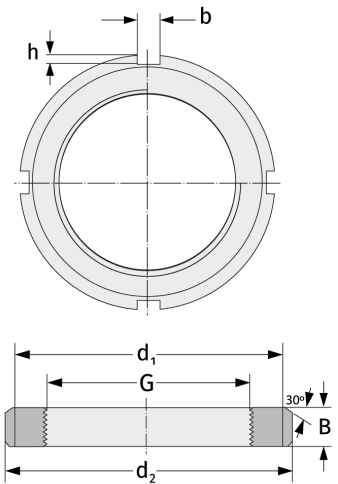

Mating dimensions

Containing components

Securing

MS30/750