

HM3084

Grooved Nuts



Details:

Main dimensions

Weight [kg]	≈ 17.4	B [mm]	52
G [mm]	Tr420x 5	b [mm]	32
		h [mm]	14
d ₁ [mm]	462		
d ₂ [mm]	490		

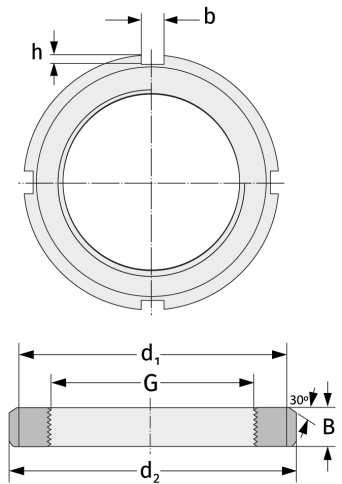

Mating dimensions

Containing components

Securing

MS3084