

# HM31/670

Grooved Nuts



## Details:

### Main dimensions

Weight [kg]	≈ 162	B [mm]	106
G [mm]	Tr670x 6	b [mm]	50
		h [mm]	28
d <sub>1</sub> [mm]	775		
d <sub>2</sub> [mm]	850		

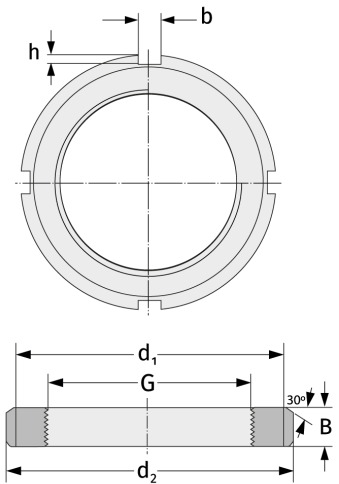

### Mating dimensions

### Containing components

Securing

MS31/670