

HM31/850

Grooved Nuts



Details:

Main dimensions

Weight [kg]	≈ 254	B [mm]	118
G [mm]	Tr850x 7	b [mm]	70
		h [mm]	38
d ₁ [mm]	975		
d ₂ [mm]	1060		

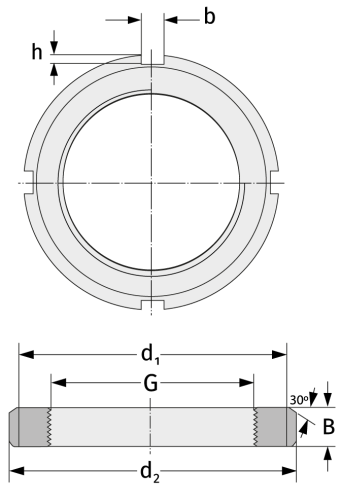

Mating dimensions

Containing components

Securing

MS31/850