

# HM3156

Grooved Nuts



## Details:

### Main dimensions

Weight [kg]	≈ 8.99	B [mm]	38
G [mm]	Tr280x 4	b [mm]	24
		h [mm]	12
d <sub>1</sub> [mm]	320		
d <sub>2</sub> [mm]	350		

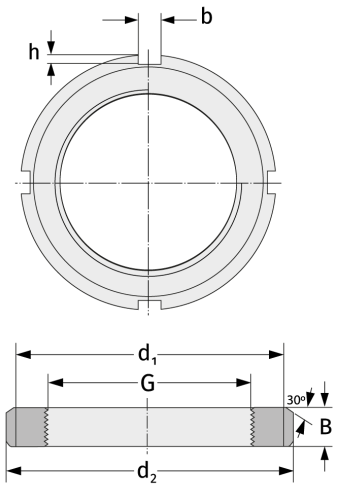

### Mating dimensions

### Containing components

Securing

MB56