

HM3176

Grooved Nuts



Details:

Main dimensions

Weight [kg]	≈ 30.8	B [mm]	60
G [mm]	Tr380x	b [mm]	32
	5	h [mm]	18
d ₁ [mm]	440		
d ₂ [mm]	490		

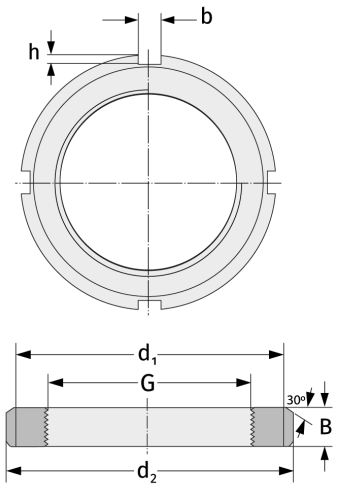

Mating dimensions

Containing components

Securing

MS3176