

KM11

Grooved Nuts



Details:

Main dimensions			
Weight [kg]	≈ 0.158	B [mm]	11
G [mm]	M55x2	b [mm]	7
d ₁ [mm]	67	h [mm]	3
d ₂ [mm]	75		

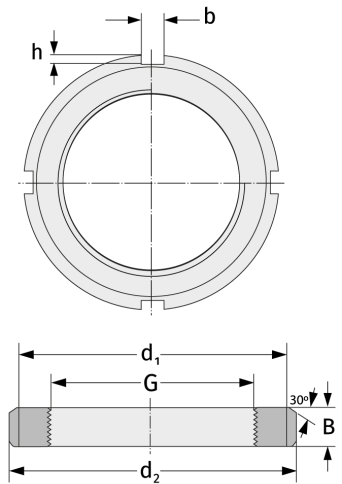

Mating dimensions

Containing components

Securing

MB11