

KM12

Grooved Nuts



Details:

Main dimensions

Weight [kg]	≈ 0.174	B [mm]	11
G [mm]	M60x2	b [mm]	7
d ₁ [mm]	73	h [mm]	3
d ₂ [mm]	80		

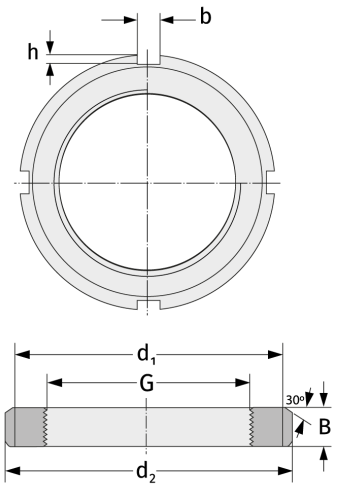

Mating dimensions

Containing components

Securing

MB12