

KM20

Grooved Nuts



Details:

Main dimensions

Weight [kg]	≈ 0.698	B [mm]	18
G [mm]	M100x 2	b [mm]	10
		h [mm]	4
d ₁ [mm]	120		
d ₂ [mm]	130		

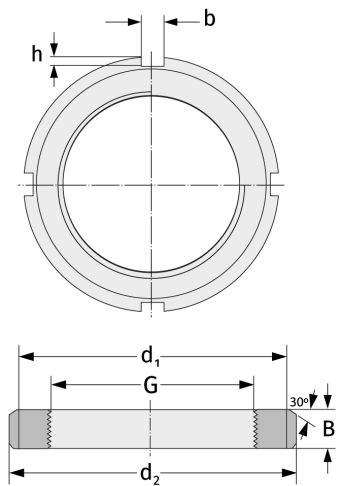

Mating dimensions

Containing components

Securing	MB20
----------	------