

KM26

Grooved Nuts



Details:

Main dimensions

Weight [kg]	≈ 1.25	B [mm]	21
G [mm]	M130x 2	b [mm]	12
		h [mm]	5
d ₁ [mm]	149		
d ₂ [mm]	165		

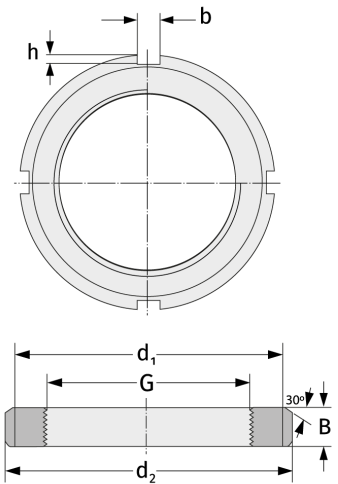

Mating dimensions

Containing components

Securing

MB26