

KM27

Grooved Nuts



Details:

Main dimensions			
Weight [kg]	≈ 1.55	B [mm]	22
G [mm]	M135x 2	b [mm]	14
		h [mm]	6
d ₁ [mm]	160		
d ₂ [mm]	175		

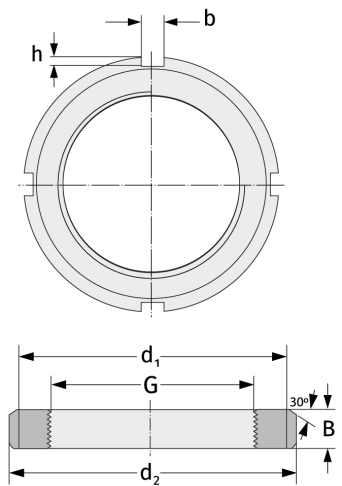

Mating dimensions

Containing components

Securing	MB27
----------	------