

# KM28

Grooved Nuts



## Details:

Main dimensions			
Weight [kg]	≈ 1.56	B [mm]	22
G [mm]	M140x 2	b [mm]	14
		h [mm]	6
d <sub>1</sub> [mm]	160		
d <sub>2</sub> [mm]	180		

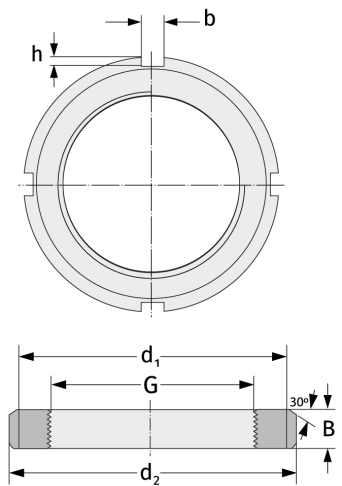

## Mating dimensions

## Containing components

Securing

MB28