

KM30

Grooved Nuts



Details:

Main dimensions			
Weight [kg]	≈ 2.03	B [mm]	24
G [mm]	M150x 2	b [mm]	14
		h [mm]	6
d ₁ [mm]	171		
d ₂ [mm]	195		

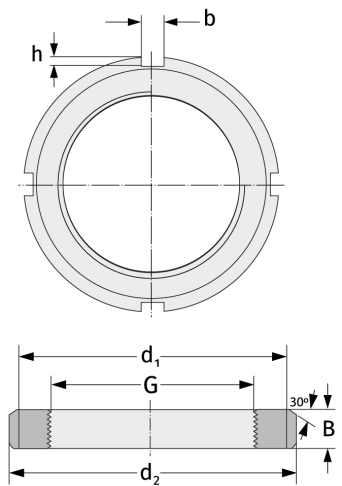

Mating dimensions

Containing components

Securing	MB30
----------	------