

# KM33

Grooved Nuts



## Details:

Main dimensions			
Weight [kg]	≈ 2.7	B [mm]	26
G [mm]	M165x 3	b [mm]	16
		h [mm]	7
d <sub>1</sub> [mm]	193		
d <sub>2</sub> [mm]	210		

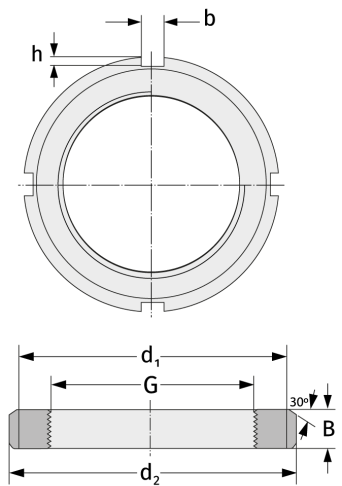

## Mating dimensions

## Containing components

Securing

MB33