

# KM38

Grooved Nuts



## Details:

Main dimensions			
Weight [kg]	≈ 3.39	B [mm]	28
G [mm]	M190x 3	b [mm]	18
		h [mm]	8
d <sub>1</sub> [mm]	214		
d <sub>2</sub> [mm]	240		

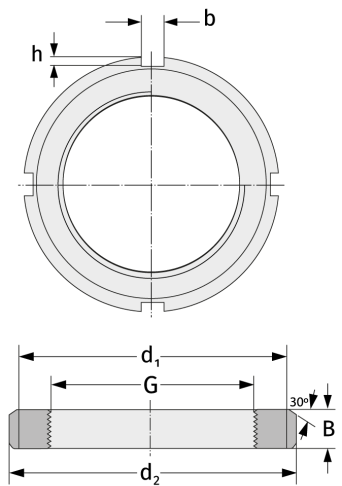

## Mating dimensions

## Containing components

Securing

MB38