

KM40

Grooved Nuts



Details:

Main dimensions

Weight [kg]	≈ 3.69	B [mm]	29
G [mm]	M200x 3	b [mm]	18
		h [mm]	8
d ₁ [mm]	226		
d ₂ [mm]	250		

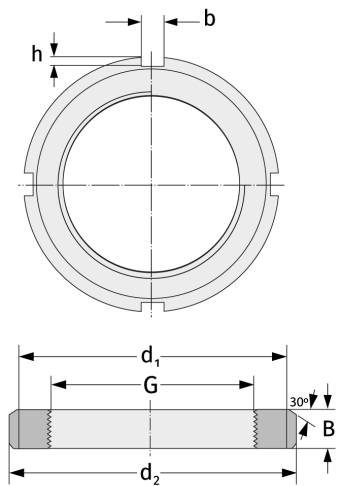

Mating dimensions

Containing components

Securing	MB40
----------	------