

KML30

Grooved Nuts



Details:

Main dimensions

Weight [kg]	≈ 1.38	B [mm]	24
G [mm]	M150x 2	b [mm]	14
		h [mm]	5
d ₁ [mm]	170		
d ₂ [mm]	180		

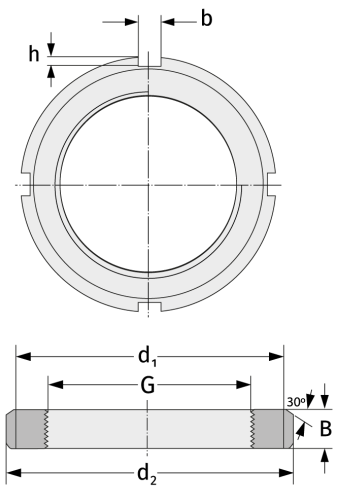

Mating dimensions

Containing components

Securing

MBL30