

KML36

Grooved Nuts



Details:

Main dimensions

Weight [kg]	≈ 1.95	B [mm]	27
G [mm]	M180x 3	b [mm]	16
		h [mm]	5
d ₁ [mm]	200		
d ₂ [mm]	210		

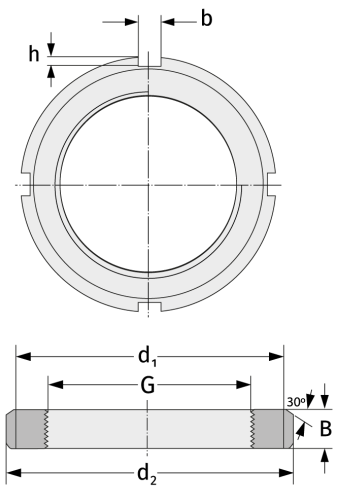

Mating dimensions

Containing components

Securing

MBL36