

# MB15

Safety Plates



## Details:

### Main dimensions

Weight [kg]	≈ 3.6	s [mm]	1.5
$d_1$ [mm]	75	$b_1$ [mm]	8
$d_2$ [mm]	104	$b_2$ [mm]	8
$d_3$ [mm]	90	M [mm]	71.5

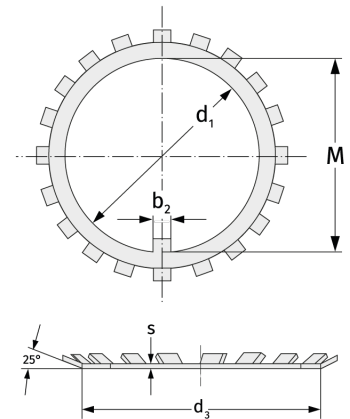

### Mating dimensions

### Calculation data