

# MB19

Safety Plates



## Details:

### Main dimensions

Weight [kg]	≈ 6.7	s [mm]	1.75
$d_1$ [mm]	95	$b_1$ [mm]	10
$d_2$ [mm]	133	$b_2$ [mm]	10
$d_3$ [mm]	113	M [mm]	91.5

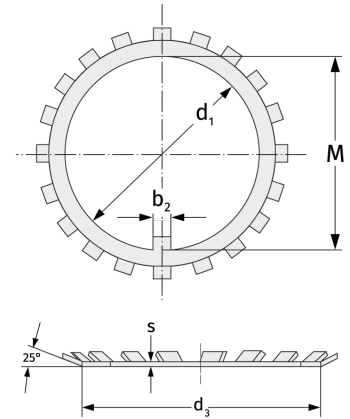

### Mating dimensions

### Calculation data