

MB20

Safety Plates



Details:

Main dimensions

Weight [kg]	≈ 7.7	s [mm]	1.75
d_1 [mm]	100	b_1 [mm]	10
d_2 [mm]	142	b_2 [mm]	12
d_3 [mm]	120	M [mm]	96.5

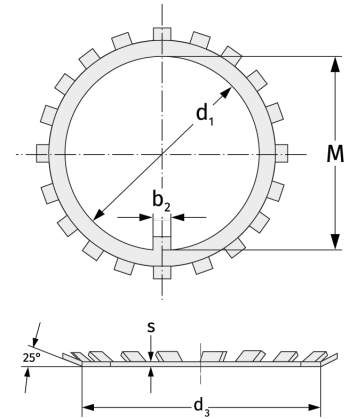

Mating dimensions

Calculation data