

NN3026S.M

Cylindrical Roller Bearings (double row, with cage)



Details:

Main dimensions

d [mm]	130	d ₁ [mm]	≈ 156.4
D [mm]	200	d _s [mm]	4.8
B [mm]	52	n _s [mm]	9.5
Weight [kg]	≈ 6.11	r _{1,2} [mm]	2
E [mm]	182	s [mm]	3.3
E [mm]	182		

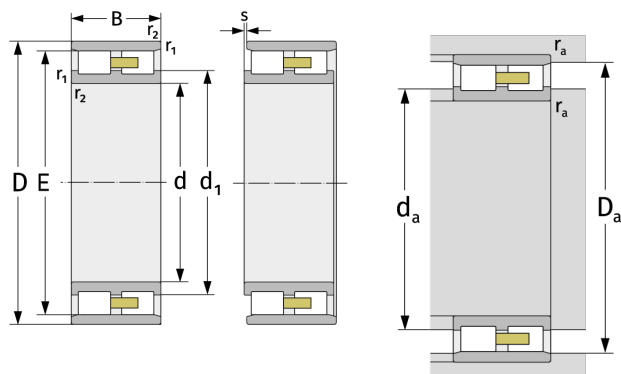

Mating dimensions		Calculation data	
D _{a,min} [mm]	183	C [kN]	300
d _{a,min} [mm]	139	C ₀ [kN]	510
D _{a,min} [mm]	183	C _u [kN]	60.1
D _{a,max} [mm]	191	n _{G,Fett} [min ⁻¹]	3900
r _{a,max} [mm]	2	n _{G,Öl-Luft} [min ⁻¹]	4600