

NNU4088S.M

Cylindrical Roller Bearings (double row, with cage)



Details:

Main dimensions

d [mm]	440	D_1 [mm]	≈ 576.6
D [mm]	650	d_s [mm]	9.5
B [mm]	212	n_s [mm]	17.7
Weight [kg]	≈ 243	$r_{1,2}$ [mm]	6
F [mm]	487	s [mm]	9.6

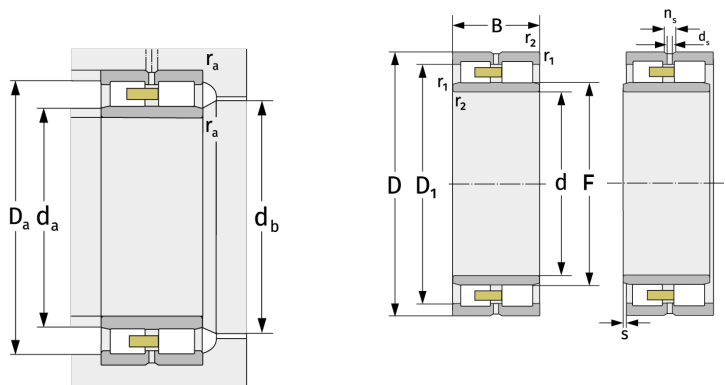

Mating dimensions		Calculation data	
$d_{a, \min}$ [mm]	463	C [kN]	3960
$d_{a, \max}$ [mm]	484	C_0 [kN]	8550
$d_{b, \min}$ [mm]	491	C_u [kN]	720
$D_{a, \max}$ [mm]	627	$n_{G, \text{Fett}}$ [min^{-1}]	1100
$r_{a, \max}$ [mm]	5	$n_{G, \text{Öl-Luft}}$ [min^{-1}]	1300