

# NNU4188S.M

Cylindrical Roller Bearings (double row, with cage)



## Details:

### Main dimensions

d [mm]	440	$D_1$ [mm]	≈ 631
D [mm]	720	$d_s$ [mm]	12.5
B [mm]	280	$n_s$ [mm]	23.5
Weight [kg]	≈ 451	$r_{1,2}$ [mm]	6
F [mm]	511	s [mm]	10.8

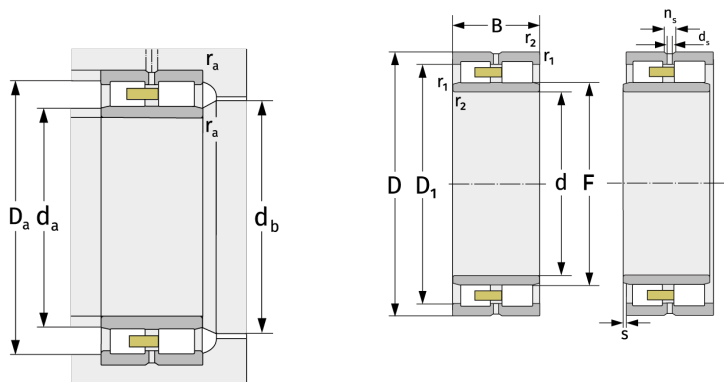

Mating dimensions		Calculation data	
$d_{a, \min}$ [mm]	466	C [kN]	5850
$d_{a, \max}$ [mm]	504	$C_0$ [kN]	11700
$d_{b, \min}$ [mm]	515	$C_u$ [kN]	965
$D_{a, \max}$ [mm]	694	$n_{G, \text{Fett}}$ [ $\text{min}^{-1}$ ]	960
$r_{a, \max}$ [mm]	5	$n_{G, \text{Öl-Luft}}$ [ $\text{min}^{-1}$ ]	1200