

# NNU48/800S.M

Cylindrical Roller Bearings (double row, with cage)



## Details:

### Main dimensions

d [mm]	800	$D_1$ [mm]	$\approx 916.8$
D [mm]	980	$d_s$ [mm]	9.5
B [mm]	180	$n_s$ [mm]	17.7
Weight [kg]	$\approx 300$	$r_{1,2}$ [mm]	5
F [mm]	856	s [mm]	8

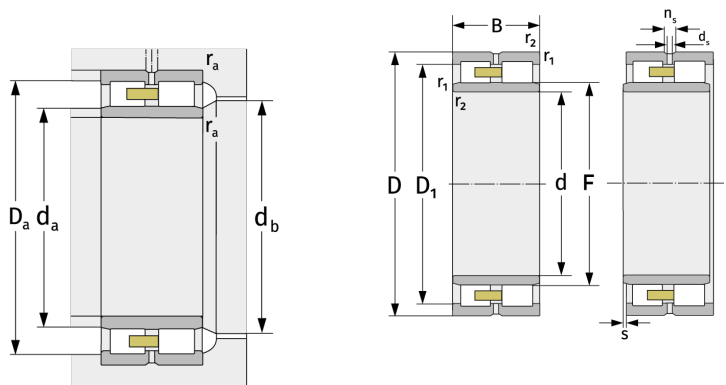

Mating dimensions		Calculation data	
$d_{a, \min}$ [mm]	818	C [kN]	3400
$d_{a, \max}$ [mm]	852	$C_0$ [kN]	11100
$d_{b, \min}$ [mm]	861	$C_u$ [kN]	810
$D_{a, \max}$ [mm]	962	$n_{G, \text{Fett}}$ [ $\text{min}^{-1}$ ]	560
$r_{a, \max}$ [mm]	4	$n_{G, \text{Öl-Luft}}$ [ $\text{min}^{-1}$ ]	660