

# NNU4856S.M

Cylindrical Roller Bearings (double row, with cage)



## Details:

### Main dimensions

d [mm]	280	$D_1$ [mm]	$\approx 326.4$
D [mm]	350	$d_s$ [mm]	4.8
B [mm]	69	$n_s$ [mm]	9.5
Weight [kg]	$\approx 15.7$	$r_{1,2}$ [mm]	2
F [mm]	302	s [mm]	3.5

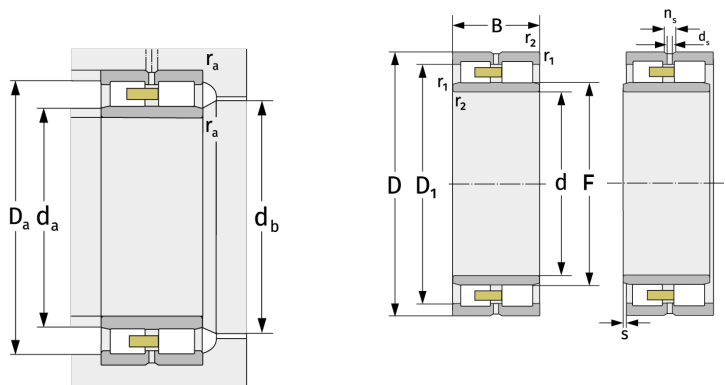

Mating dimensions		Calculation data	
$d_{a, \min}$ [mm]	289	C [kN]	498
$d_{a, \max}$ [mm]	300	$C_0$ [kN]	1350
$d_{b, \min}$ [mm]	305	$C_u$ [kN]	133
$D_{a, \max}$ [mm]	341	$n_{G, \text{Fett}}$ [ $\text{min}^{-1}$ ]	2000
$r_{a, \max}$ [mm]	2	$n_{G, \text{Öl-Luft}}$ [ $\text{min}^{-1}$ ]	2300