

# NNU49/710S.M

Cylindrical Roller Bearings (double row, with cage)



## Details:

### Main dimensions

d [mm]	710	$D_1$ [mm]	$\approx 871.6$
D [mm]	950	$d_s$ [mm]	12.5
B [mm]	243	$n_s$ [mm]	23.5
Weight [kg]	$\approx 495$	$r_{1,2}$ [mm]	6
F [mm]	782	s [mm]	9.8

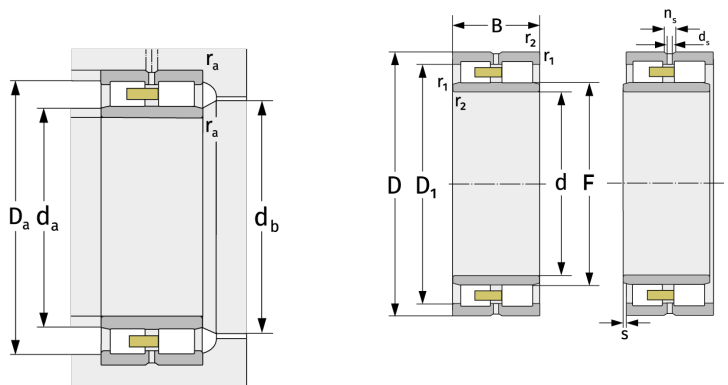

Mating dimensions		Calculation data	
$d_{a, \min}$ [mm]	733	C [kN]	5550
$d_{a, \max}$ [mm]	777	$C_0$ [kN]	15300
$d_{b, \min}$ [mm]	787	$C_u$ [kN]	1140
$D_{a, \max}$ [mm]	927	$n_{G, \text{Fett}}$ [ $\text{min}^{-1}$ ]	610
$r_{a, \max}$ [mm]	5	$n_{G, \text{Öl-Luft}}$ [ $\text{min}^{-1}$ ]	720