

NNU4988S.M

Cylindrical Roller Bearings (double row, with cage)



Details:

Main dimensions

d [mm]	440	D_1 [mm]	≈ 544.4
D [mm]	600	d_s [mm]	9.5
B [mm]	160	n_s [mm]	17.7
Weight [kg]	≈ 136	$r_{1,2}$ [mm]	4
F [mm]	490	s [mm]	6.8

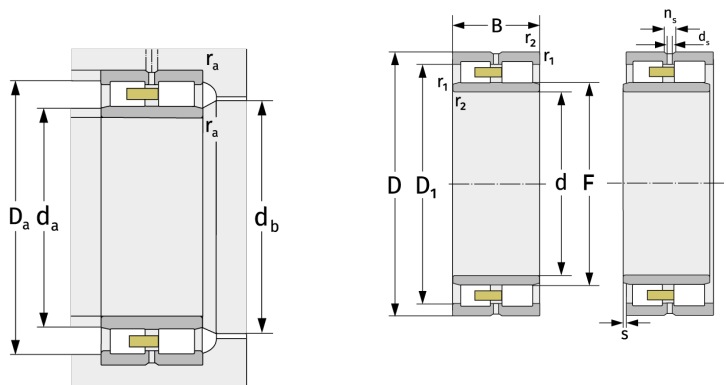

Mating dimensions		Calculation data	
$d_{a, \min}$ [mm]	455	C [kN]	2100
$d_{a, \max}$ [mm]	486	C_0 [kN]	5350
$d_{b, \min}$ [mm]	494	C_u [kN]	454
$D_{a, \max}$ [mm]	585	$n_{G, \text{Fett}}$ [min^{-1}]	1100
$r_{a, \max}$ [mm]	3	$n_{G, \text{Öl-Luft}}$ [min^{-1}]	1300