

# NNU4992S.M

Cylindrical Roller Bearings (double row, with cage)



## Details:

### Main dimensions

d [mm]	460	$D_1$ [mm]	$\approx 564.4$
D [mm]	620	$d_s$ [mm]	9.5
B [mm]	160	$n_s$ [mm]	17.7
Weight [kg]	$\approx 142$	$r_{1,2}$ [mm]	4
F [mm]	510	s [mm]	6.8

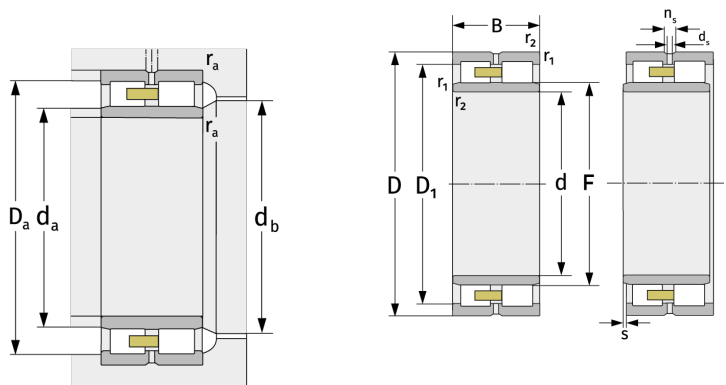

Mating dimensions		Calculation data	
$d_{a, \min}$ [mm]	475	C [kN]	2180
$d_{a, \max}$ [mm]	506	$C_0$ [kN]	5650
$d_{b, \min}$ [mm]	514	$C_u$ [kN]	475
$D_{a, \max}$ [mm]	605	$n_{G, \text{Fett}}$ [ $\text{min}^{-1}$ ]	1100
$r_{a, \max}$ [mm]	3	$n_{G, \text{Öl-Luft}}$ [ $\text{min}^{-1}$ ]	1300