

NNU6010V

Cylindrical Roller Bearings (full complement, multi row)



Details:

Main dimensions

d [mm]	50	d_s [mm]	3.2
D [mm]	80	n_s [mm]	4.8
B [mm]	54	$r_{1,2}$ [mm]	1
Weight [kg]	≈ 1.15	$r_{3,4}$ [mm]	1
D_1 [mm]	≈ 69		

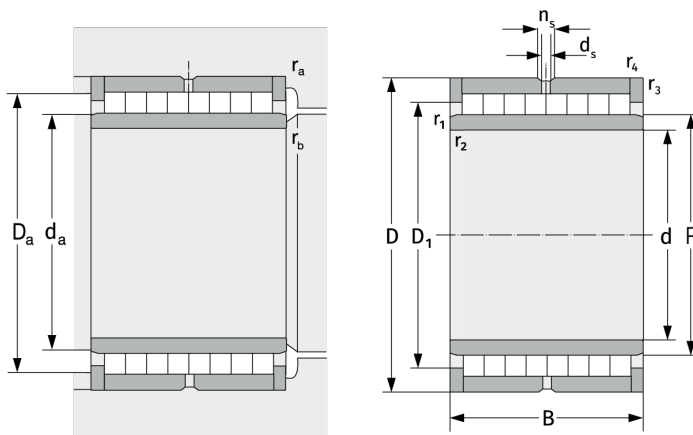

Mating dimensions

$d_{a, \min}$ [mm]	55
$D_{a, \max}$ [mm]	75
$r_{a, \max}$ [mm]	1
$r_{b, \max}$ [mm]	1

Calculation data

C [kN]	161
C_0 [kN]	340
C_u [kN]	44.7