

NNU6018V

Cylindrical Roller Bearings (full complement, multi row)



Details:

Main dimensions

d [mm]	90	d_s [mm]	3.2
D [mm]	140	n_s [mm]	4.8
B [mm]	90	$r_{1,2}$ [mm]	1.5
Weight [kg]	≈ 5.66	$r_{3,4}$ [mm]	1.5
D_1 [mm]	≈ 121.25		

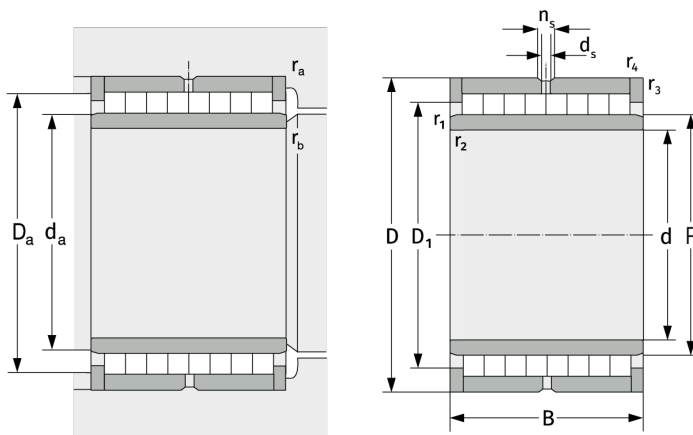

Mating dimensions

$d_{a, \min}$ [mm]	97
$D_{a, \max}$ [mm]	133
$r_{a, \max}$ [mm]	1.5
$r_{b, \max}$ [mm]	1.5

Calculation data

C [kN]	441
C_0 [kN]	1050
C_u [kN]	137