

NNU6028V

Cylindrical Roller Bearings (full complement, multi row)



Details:

Main dimensions

d [mm]	140	d_s [mm]	3.2
D [mm]	210	n_s [mm]	6.5
B [mm]	125	$r_{1,2}$ [mm]	2
Weight [kg]	≈ 16.8	$r_{3,4}$ [mm]	2
D_1 [mm]	≈ 183.4		

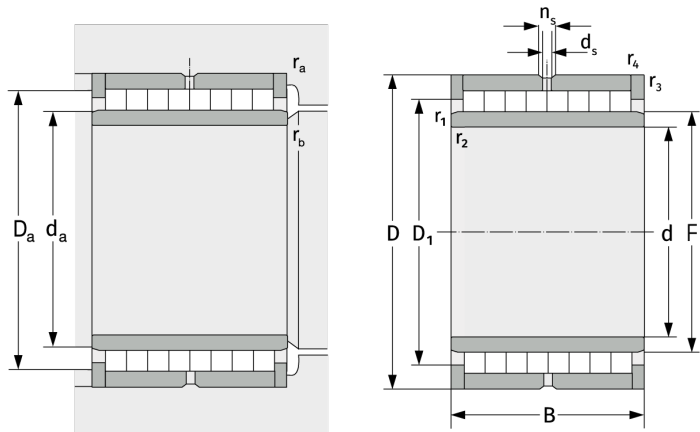

Mating dimensions

$d_{a, \min}$ [mm]	149
$D_{a, \max}$ [mm]	201
$r_{a, \max}$ [mm]	2
$r_{b, \max}$ [mm]	2

Calculation data

C [kN]	875
C_0 [kN]	2270
C_u [kN]	263