

NNU6056V

Cylindrical Roller Bearings (full complement, multi row)



Details:

Main dimensions

d [mm]	280	d_s [mm]	4.8
D [mm]	420	n_s [mm]	9.5
B [mm]	250	$r_{1,2}$ [mm]	4
Weight [kg]	≈ 134	$r_{3,4}$ [mm]	4
D_1 [mm]	≈ 366.3		

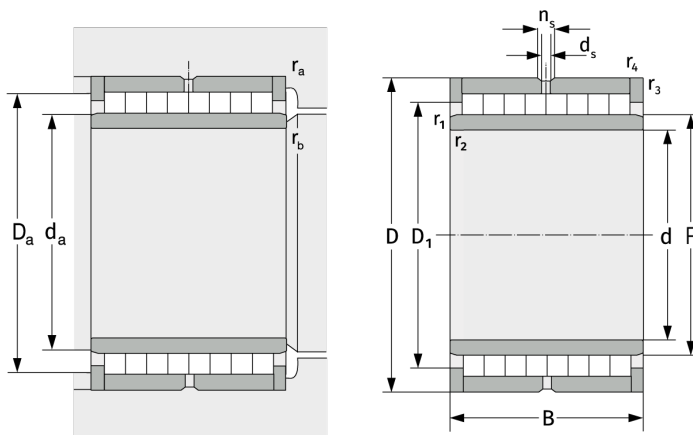

Mating dimensions

$d_{a, \min}$ [mm]	295
$D_{a, \max}$ [mm]	405
$r_{a, \max}$ [mm]	3
$r_{b, \max}$ [mm]	3

Calculation data

C [kN]	3180
C_0 [kN]	9200
C_u [kN]	876