

# NNU6072V

Cylindrical Roller Bearings (full complement, multi row)



## Details:

### Main dimensions

d [mm]	360	$d_s$ [mm]	4.8
D [mm]	540	$n_s$ [mm]	9.5
B [mm]	325	$r_{1,2}$ [mm]	5
Weight [kg]	≈ 288	$r_{3,4}$ [mm]	5
$D_1$ [mm]	≈ 470.6		

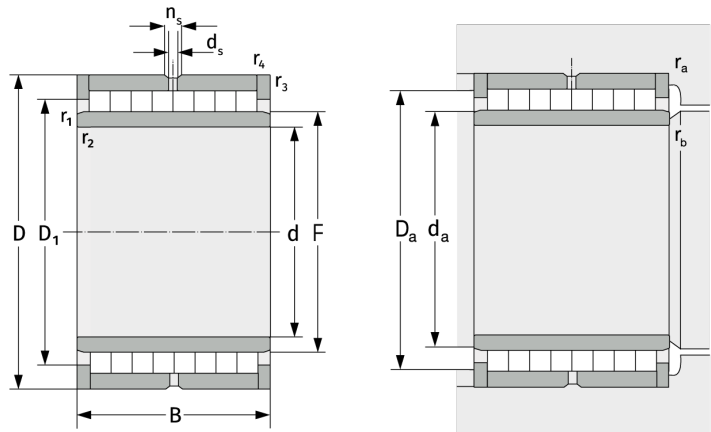

### Mating dimensions

$d_{a, \min}$ [mm]	378
$D_{a, \max}$ [mm]	522
$r_{a, \max}$ [mm]	4
$r_{b, \max}$ [mm]	4

### Calculation data

C [kN]	5100
$C_0$ [kN]	15300
$C_u$ [kN]	1357