

NNU6076V

Cylindrical Roller Bearings (full complement, multi row)



Details:

Main dimensions

d [mm]	380	d_s [mm]	6.3
D [mm]	560	n_s [mm]	12.2
B [mm]	325	$r_{1,2}$ [mm]	5
Weight [kg]	≈ 300	$r_{3,4}$ [mm]	5
D_1 [mm]	≈ 493.6		

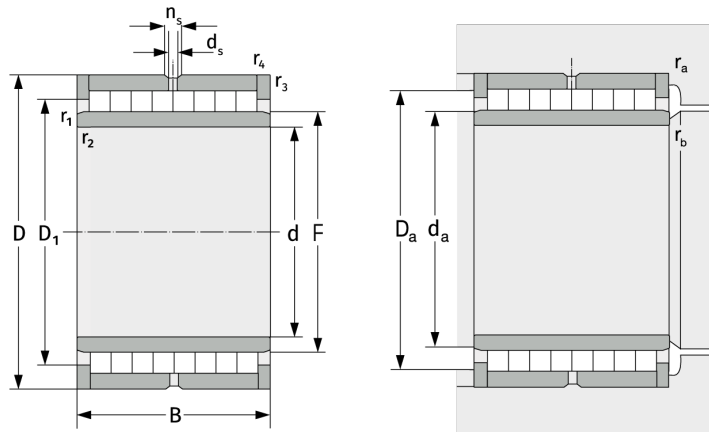

Mating dimensions

$d_{a, \min}$ [mm]	398
$D_{a, \max}$ [mm]	542
$r_{a, \max}$ [mm]	4
$r_{b, \max}$ [mm]	4

Calculation data

C [kN]	5250
C_0 [kN]	16200
C_u [kN]	1416