

NNU6926V

Cylindrical Roller Bearings (full complement, multi row)



Details:

Main dimensions

d [mm]	130	d_s [mm]	3.2
D [mm]	180	n_s [mm]	6.5
B [mm]	90	$r_{1,2}$ [mm]	1.5
Weight [kg]	≈ 7.64	$r_{3,4}$ [mm]	1.5
D_1 [mm]	≈ 159.5		

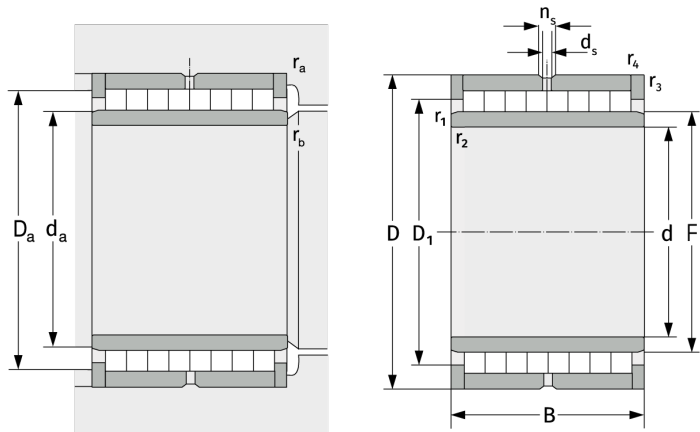

Mating dimensions

$d_{a, \min}$ [mm]	137
$D_{a, \max}$ [mm]	173
$r_{a, \max}$ [mm]	1.5
$r_{b, \max}$ [mm]	1.5

Calculation data

C [kN]	520
C_0 [kN]	1430
C_u [kN]	172