

# NNU6934V

Cylindrical Roller Bearings (full complement, multi row)



## Details:

### Main dimensions

d [mm]	170	$d_s$ [mm]	3.2
D [mm]	230	$n_s$ [mm]	6.5
B [mm]	109	$r_{1,2}$ [mm]	2
Weight [kg]	≈ 14.3	$r_{3,4}$ [mm]	2
$D_1$ [mm]	≈ 206.7		

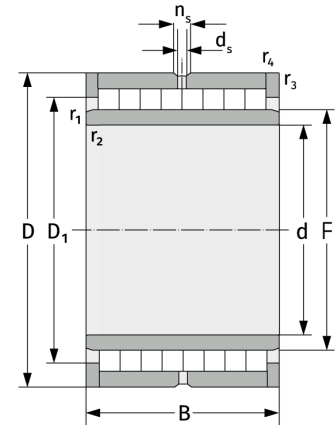
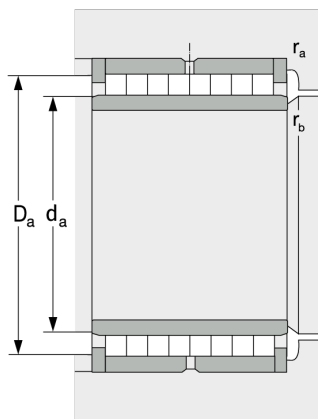

### Mating dimensions

$d_{a, \min}$ [mm]	179
$D_{a, \max}$ [mm]	221
$r_{a, \max}$ [mm]	2
$r_{b, \max}$ [mm]	2

### Calculation data

C [kN]	775
$C_0$ [kN]	2280
$C_u$ [kN]	255