

30256

Tapered Roller Bearings (single row, metric)



Details:

Main dimensions			
d [mm]	280	B [mm]	80
D [mm]	500	d ₁ [mm]	≈ 375.3
T [mm]	89	r _{1,2} [mm]	6
Weight [kg]	≈ 65.5	r _{3,4} [mm]	5
C [mm]	67	a [mm]	≈ 94.8

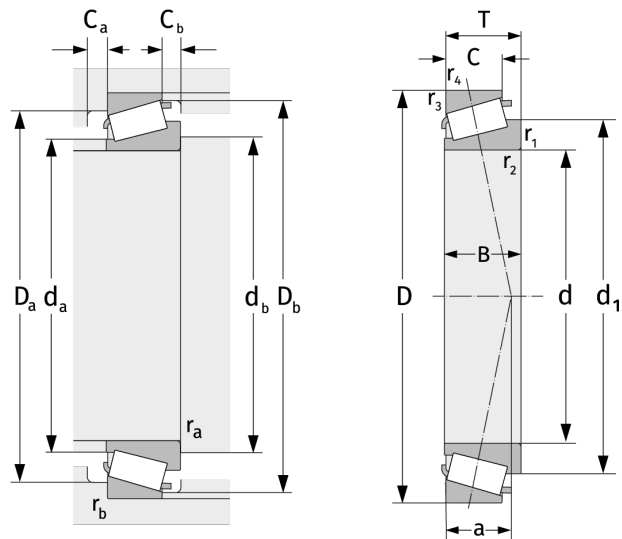

Mating dimensions		Calculation data	
d _{a,max} [mm]	330	C [kN]	1480
d _{b,min} [mm]	300	C ₀ [kN]	2210
D _{a,min} [mm]	433	C _u [kN]	186
D _{a,max} [mm]	477	n _{th} [min ⁻¹]	801
D _{b,min} [mm]	465	n _g [min ⁻¹]	1300
C _{a,min} [mm]	12	e	0,44
C _{b,min} [mm]	22	Y	1,38
r _{a,max} [mm]	6	Y ₀	0,76
r _{b,max} [mm]	5		