

HM3052

Grooved Nuts



Details:

Main dimensions

Weight [kg]	≈ 5.67	B [mm]	34
G [mm]	Tr260x 4	b [mm]	20
		h [mm]	10
d ₁ [mm]	290		
d ₂ [mm]	310		

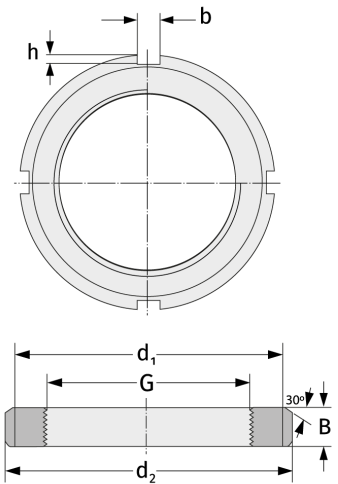

Mating dimensions

Containing components

Securing

MS3048