

HM3060

Grooved Nuts



Details:

Main dimensions

Weight [kg]	≈ 9.62	B [mm]	42
G [mm]	Tr300x 4	b [mm]	24
		h [mm]	12
d ₁ [mm]	336		
d ₂ [mm]	360		

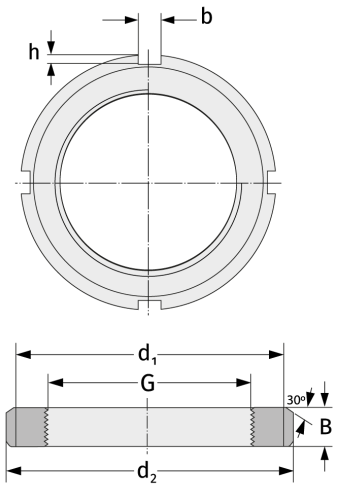

Mating dimensions

Containing components

Securing

MS3060