

HM3064

Grooved Nuts



Details:

Main dimensions

Weight [kg]	≈ 9.94	B [mm]	42
G [mm]	Tr320x 5	b [mm]	24
		h [mm]	12
d ₁ [mm]	356		
d ₂ [mm]	380		

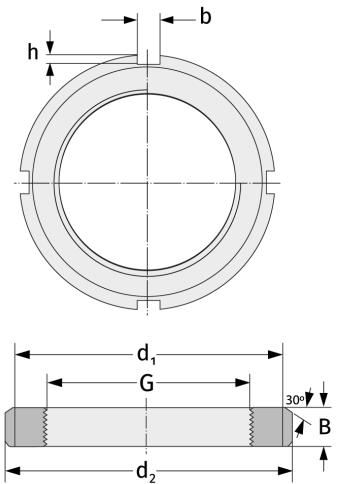

Mating dimensions

Containing components

Securing

MS3064