

# HM3076

Grooved Nuts



## Details:

### Main dimensions

Weight [kg]	≈ 14.9	B [mm]	48
G [mm]	Tr380x 5	b [mm]	28
		h [mm]	14
d <sub>1</sub> [mm]	422		
d <sub>2</sub> [mm]	450		

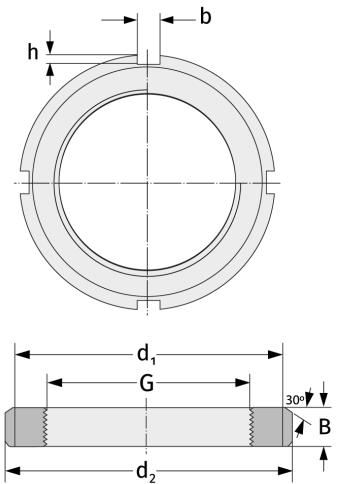

### Mating dimensions

### Containing components

Securing

MS3076