

HM3080

Grooved Nuts



Details:

Main dimensions

Weight [kg]	≈ 16.9	B [mm]	52
G [mm]	Tr400X 5	b [mm]	28
		h [mm]	14
d ₁ [mm]	442		
d ₂ [mm]	470		

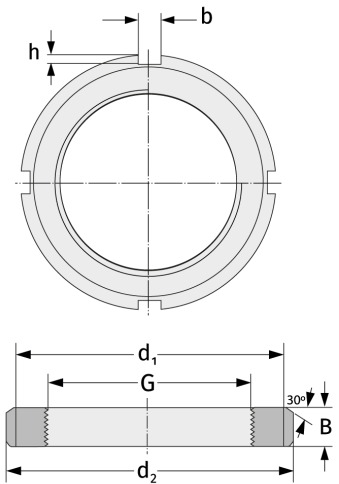

Mating dimensions

Containing components

Securing

MS3076