

HM3148

Grooved Nuts



Details:

Main dimensions

Weight [kg]	≈ 5.91	B [mm]	34
G [mm]	Tr240x 4	b [mm]	20
		h [mm]	10
d ₁ [mm]	270		
d ₂ [mm]	300		

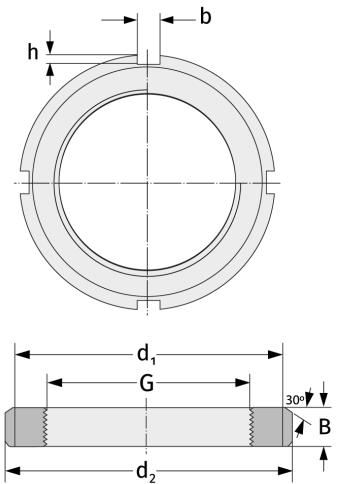

Mating dimensions

Containing components

Securing

MB48