

HM3172

Grooved Nuts



Details:

Main dimensions

Weight [kg]	≈ 25	B [mm]	58
G [mm]	Tr340x5	b [mm]	28
		h [mm]	15
d ₁ [mm]	420		
d ₂ [mm]	460		

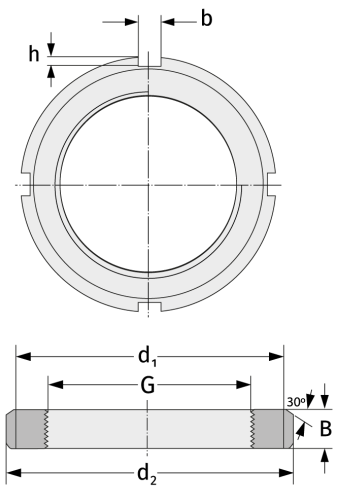

Mating dimensions

Containing components

Securing

MS3168