

KM1

Grooved Nuts



Details:

Main dimensions			
Weight [kg]	≈ 0.007	B [mm]	4
G [mm]	M12x1	b [mm]	3
d ₁ [mm]	17	h [mm]	2
d ₂ [mm]	22		

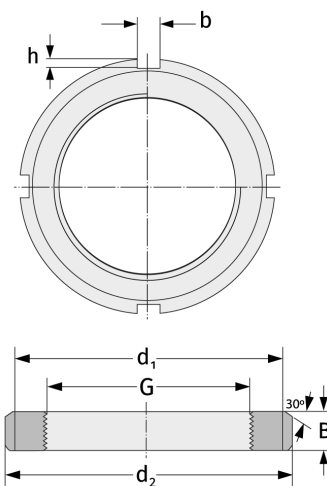

Mating dimensions

Containing components

Securing

MB1